







Technische Daten	SLK X	SLK X SKII
Material	PC weiss (Gehäuse & Drücker)	PC weiss (Drücker)
	PC transparent (Deckel)	PA 66 beige (Gehäuse) PA 66 natur (Deckel)
	Kupfer verzinkt (Kontaktteile)	Kupfer verzinkt (Kontaktteile)
	IEC60998-1	IEC60598
Nennspannung	450 V	300 V (für verstärkte Isolierung Schutzklasse II)
Nennstrom	24 A	24 A
Maximale Umgebungstemperatur	T85	T85
Abisolierlänge	9 - 10 mm	9 - 10 mm
Prüfzeichen (geplant)	 11	
UL1059		
AWG	10 - 20	
Nennspannung	300 V	
Prüfzeichen (geplant)	 US	

Ratings	SLK X	SLK X SKII
Material	PC white (housing & release button)	PC white (release button)
	PC transparent (cover)	PA 66 beige (housing) PA 66 natural (cover)
	Tinned copper (contact parts)	Tinned copper (contact parts)
	IEC60998-1	IEC60598
Nominal voltage	450 V	300 V (for reinforced insulation protection class II)
Nominal current	24 A	24 A
Max. ambient temperature	T85	T85
Wire stripping length	9 - 10 mm	9 - 10 mm
Approvals (planned)	 11	
UL1059		
AWG	10 - 20	
Nominal voltage	300 V	
Approvals (planned)	 US	

Technische Änderungen vorbehalten.
We reserve the right to make technical changes without prior notice.

BETTER CONNECTIONS

Wir liefern die perfekte Verbindungslösung für Ihre Anwendung im Bereich Leuchten, Haushaltsgeräte und Installation. Electro Terminal ist ein internationales Unternehmen mit mehr als 65 Vertriebspartnern auf allen Kontinenten. Ihren regionalen Ansprechpartner finden Sie am einfachsten unter www.electroterminal.com. We provide the perfect connection solutions for your applications in the lighting, household appliance and installation sectors. Electro Terminal is an international company with more than 65 sales partners on all continents. The easiest way to find your regional contact is to check our website at www.electroterminal.com.

Electro Terminal GmbH & Co KG
Archenweg 58 | 6020 Innsbruck | Austria
T +43 512 3321
www.electroterminal.com
office@electroterminal.com



SLK X

Schraubenlose Leuchtenanschlussklemme Screwless Luminaire Connector

- Gleiches Lochbild wie SLK 5
Same cutout as SLK 5
- Kompakte Abmessungen
Compact dimensions
- Verschiedene Befestigungs- und Erdvarianten
Different fixing and earthing variants
- Passend für Zugentlastung SLK 7
Suitable for strain relief SLK 7
- Auch als SKII Variante erhältlich
Also available as SKII variant

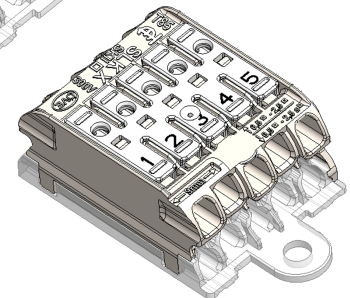
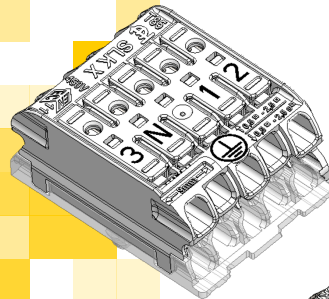

ELECTRO
TERMINAL

Abmessungen | *Dimensions:* 37 mm x 27.9 mm x 16 mm

Anschluss oben: 0,5 - 2,5mm² (s.r.f)
 Leiter lösbar mittels Schraubenzieher / Drücker
Upper terminal: 0.5 - 2.5mm² (s.r.f)
Wire releasable with screw driver / push-button

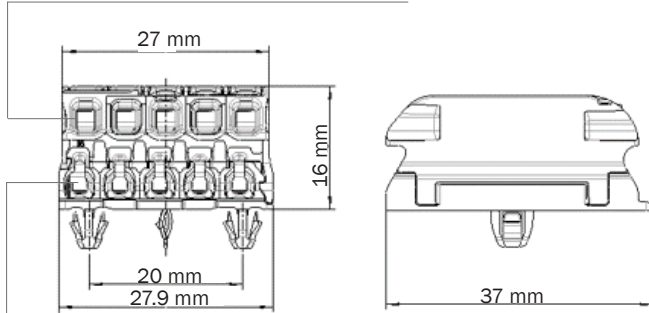

Anschluss unten: 0,5 - 2,5mm² (s), 1,5 - 2,5 mm² (r)
 Leiter lösbar mittels Lösestift / Drehen & Ziehen
Lower terminal: 0.5 - 2.5mm² (s), 1.5 - 2.5 mm² (r)
Detachment of wire with release pin / twist & pull

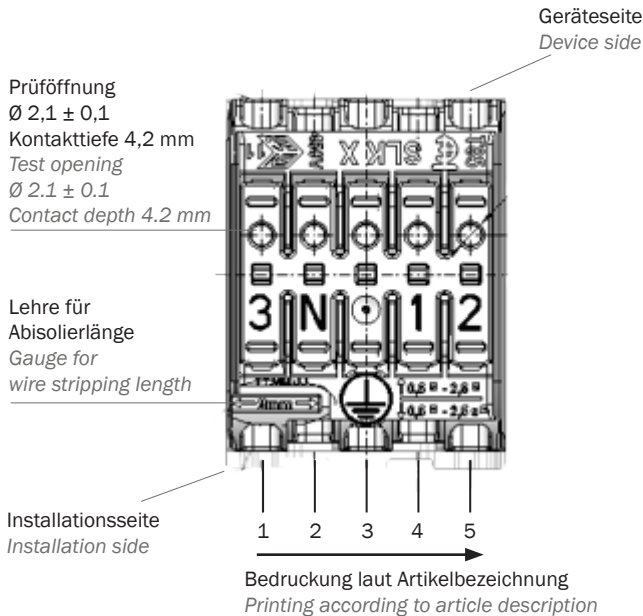

Befestigungs- und Erdungsvarianten | *Fixing and earthing variants*

gleiches Lochbild wie SLK 5 | *same cutout as SLK 5*

SLK X/5 OF Ohne Befestigungszapfen | *Without fixing pins*

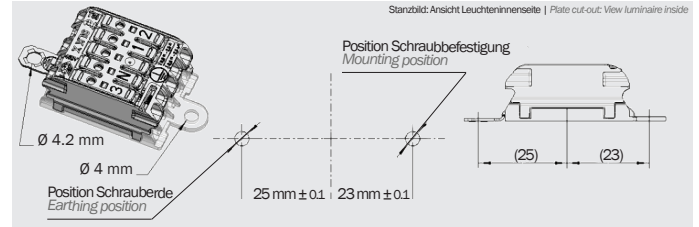

SLK X/5 ALP Befestigungsfuß für Aluminiumprofile | *Fixing pin for aluminium profile*

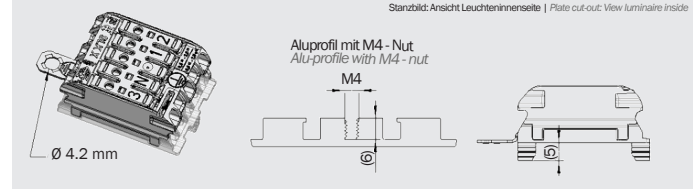

SLK X/5 E-PIEC Steckerde | *Push-in-Earth-Contact*

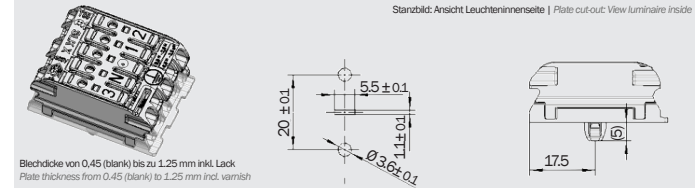

SLK X/5 Befestigungszapfen | *Fixing pins*

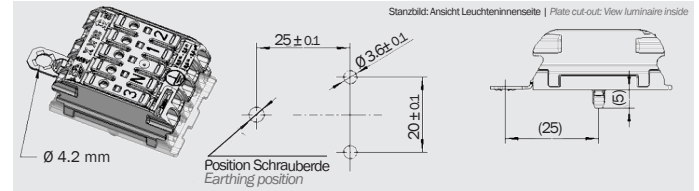

Zubehör | *Accessories*

